

人體工學及健康工作間 Ergonomic & Well Being Office



為你打造健康舒適工作空間



- A 螢幕頂部與視線保持成水平線
- B 藍光則是能量較強的可見光，包括藍、靛、紫光，吸收過量藍光會導致近視、白內障，甚至造成黃斑部感光細胞的損傷
- C 保持肩膊放鬆
- D 坐姿挺直調校高度和斜度靠背可減低背部壓力
- E 維持手肘90度角，調整坐姿及座位高度，可放鬆上半身壓力
- F 膝頭90度角腳掌著地，可放鬆下半身壓力
- G 如經常把腳放上椅腳上，代表大腿血管都需要放鬆

19

人體工學不僅僅給您帶來方便 更重要的是健康



長期久坐
腿不舒服



姿勢不對
腰酸背痛



脖子前傾
頸椎變形



久坐 腰酸 壓迫脊椎

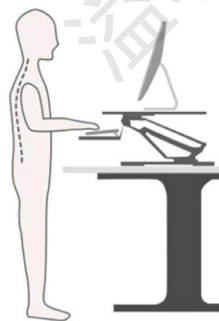

站坐結合 健康辦公
有效舒緩頸頸勞損

新人體工學產品介紹

參考頁數 P.105-112



顯示器專用旋轉臂



WS01
顯示器+鍵盤專用架



GM-124D
雙臂顯示器專用架



GM-112D
單臂顯示器專用架



GM-134D
三臂顯示器專用架

YouTube



GM-112D安裝教程

人體工學及健康工作間

Ergonomic & Well Being Office

WIPAS®



WPS-GHED121D-G2
電動升降工作檯(坐站兩用)

智 者 之 選

智能 · 電動 · 升降

- 4檔記憶高度
- 遇阻回退功能
- IP20防水防塵等級
- 配備USB 3.0插口及無線充電裝置
- 鋼化玻璃檯面+鋼製腳架
- 檯面升降範圍28"-47"(720-1200mm)
- 最大承重110 lbs(50kg)



檯面尺寸1200*600mm



WIPAS
ERGONOMIC
PRODUCTS



Wireless
Charging
無線充電

amfori @BSCI
Trade with purpose

SGS

ROHS

CE

新人體工學產品介紹

參考頁數 P.105-112



電動升降枱



FDE104
桌面尺寸: 600x600mm
最大承重: 40kg
桌面高度: 600-1200mm

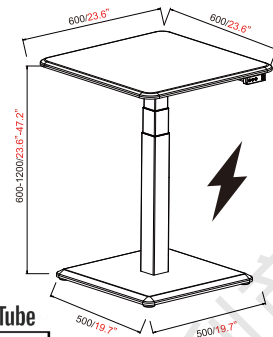

YouTube



掃碼查看FDE-104介紹

YouTube



掃碼查看FDE-104安裝教程

19



電動升降枱



安全認證: UL, CE, FCC, DOC, EMC

YouTube



GHED121D-G2介紹



抽屜



鋼化玻璃桌面



配備2個USB 3.0插口
和1個Type-C插口

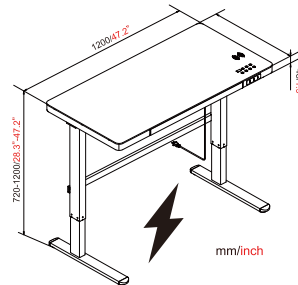

GHED121D-G2
桌面尺寸: 1200x600mm
最大承重: 50kg
桌面高度: 720-1200mm

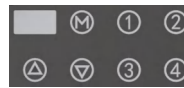

可自設4個記憶高度



流動升降桌



FDS107F
大板: 695x555x15mm
小板: 515x400x15mm



FDS107D-2
大板: 700x400x15mm
小板: 700x150x15mm



FDS107F
筆槽杯槽
配套齊全



把手調節升降
適合不同需求

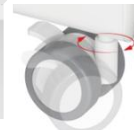

帶鎖萬向輪
隨停隨移



經受50000次
測試氣彈簧

YouTube



FDS107F介紹

YouTube



FDS107D-2介紹

YouTube



FDS107系列安裝視頻

人體工學及健康工作間

Ergonomic & WellBeing Office

19

人體工學及健康工作間

Ergonomic & Well Being Office



可調校坐立式桌面電腦工作站

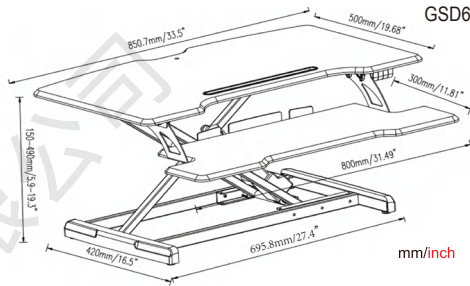

GSD66HCE安裝及介紹教程

YouTube



GSD66HCE
 桌面板: 850.7x500mm
 鍵盤板: 800x300mm
 最大承重: 桌面13kg/鍵盤板2kg
 桌面高度: 150-490mm(電動升降)

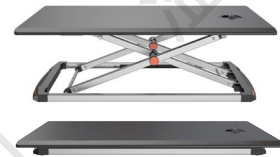
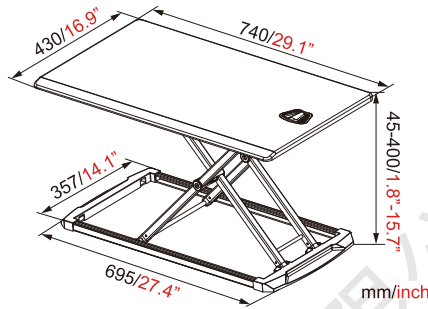

折疊後高度45mm

SD15
 桌面尺寸: 740x430mm
 最大承重: 10kg
 桌面高度: 45-400mm(無級調節升降)



顯示屏幕座

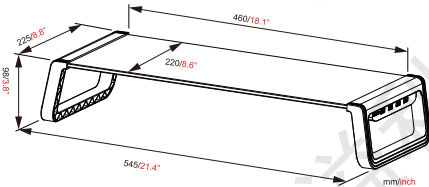

MR09C有白色選



MR09設USB接口,方便手提充電

鋼化玻璃面
 產品尺寸: 460x225x98mm
 最大承重: 5kg
 Model: MR09 (4 USB插口)
 Model: MR09C

YouTube



MR09系列介紹



可調高度顯示屏幕座

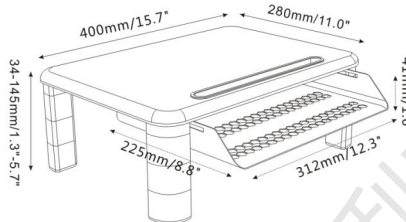

YouTube



QA-MR01介紹



腳可拆卸調校高度



A4文件籃

· 三段高度調校
 · 前端插槽可放手提電話/平板電腦
 · 台下附推拉式A4文件籃

塑膠顯示屏幕座
QA-MR01
 桌面尺寸: 400x280mm
 高度: 68mm/104mm/142mm
 最大承重: 10kg





金屬手提電腦支架連USB擴充插口



D50-3
產品尺寸: 260x230mm
適用尺寸: 16" 以下手提電腦
調節高度: 40-320mm



金屬手提電腦旋轉支架

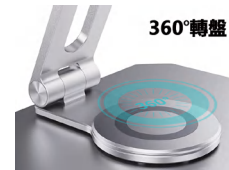

- 鋁合金架+防滑膠
- 底座360°旋轉
- 關節180°調校

L02
產品尺寸: 280x260mm
適用尺寸: 16" 以下手提電腦
調節高度: 30-365mm



便攜式金屬手提電腦支架



- 鋁合金架+防滑膠

- 鋁合金支架,散熱度快,增強電腦運算速度
- 收納快捷,附布袋方便攜帶

A003
產品尺寸: 275x30mm
適用尺寸: 16" 以下手提電腦
最大承重: 25kg
調節範圍: 6檔傾斜角度調節



夾枱式前手臂托架

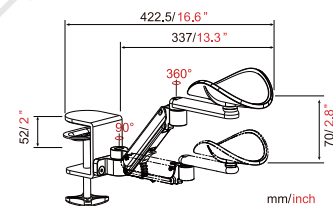
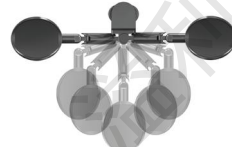
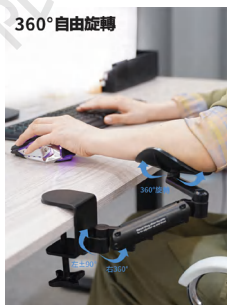

EH01
產品尺寸: 128x110mm
關節/托架旋轉: 180°
最大承重: 5kg

保持頭部自然位置，可減輕頸椎壓力

LUMI®
home | ergo | pro

電動升降坐立式辦公桌
參考頁數 P.102



3M

3M™ Easy-adjust Monitor Arm, Black
桌面顯示器專用旋臂

保持頭部自然位置，可減輕頸椎壓力
參考頁數 P.104

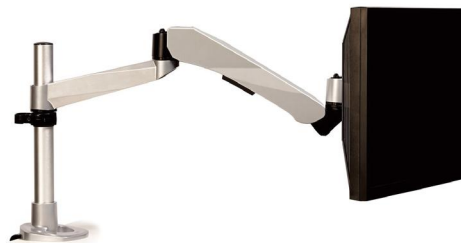

19

© **ergotron**

Ergotron® WorkFit Workstation
WorkFit 工作站帶工作枱面

參考頁數 P.106



SIT. STAND. SWITCH.
健康建議!

每半小時轉換一吓坐立姿勢

保護眼睛，減底眼睛疲累及藍光傷害

3M

3M™ Privacy Filter
3M™ LCD 螢幕防窺濾鏡

- 螢幕防窺片助您保護機密資料。僅有位於螢幕正前方的使用者可看到螢幕上的內容，旁人只能看見變暗的螢幕。
 - 予您兩種便利的安裝方式。可翻面、無光澤的一面減少眩光和反光。
 - 輕、薄的無框設計，防止顯示器螢幕上的灰塵、碎片和刮痕。使用軟布及水即可輕鬆清潔。
 - 可減少35%螢幕藍光。
- 參考頁數 P.101



Philips LED Table Light
飛利浦LED枱燈

參考頁數 P.79



保持肩膊放鬆

Plantronic Telephone Wireless Headset
電話無線耳機

肩膊保持放鬆
參考頁數 P.154



人體工學及健康工作間

Ergonomic & Well Being Office

減低背部壓力

OBUS FORME® Backrest 專業背墊

坐姿挺直可減低背部壓力
參考頁數 P.159



Foldable Backrest Cushion Chair 健康護脊坐墊

坐姿挺直可減低背部壓力
參考頁數 P.159



Kensington®

Kensington® Memory Foam Back Support / Seat Rest 專業系列背墊/坐墊

坐姿挺直可減低背部壓力
參考頁數 P.159



19

維持手踭90度角，可放鬆上半身壓力

3M

3M™ Adjustable Keyboard Drawer 3M™ 調校式鍵盤托

維持手踭90度角，代表坐姿及坐位高度調整正確，可放鬆上半身壓力
參考頁數 P.113



Fellowes

Fellowes Underdesk Keyboard Drawer 鑽檯式可調較鍵盤托

維持手踭90度角，代表坐姿及坐位高度調整正確，可放鬆上半身壓力
參考頁數 P.112



HOLLIES
ERGO ACCESSORIES

Hollies SL-449 Underdesk Keyboard Drawer W/ Mouse Tray 桌底鍵盤托

維持手踭90度角，代表坐姿及坐位高度調整正確，可放鬆上半身壓力
參考頁數 P.112



Memory Foam Mouse Pad 記憶棉腕墊

參考頁數 P.118



保持膝頭90度，腿部血管放鬆

3M

3M™ Adjustable Footrest 可調校高級適體腳踏

腳掌到地不代表正常位置，後大腿血管都需要放鬆，如果你經常把腳放上椅腳上，代表大腿血管都需要放鬆
參考頁數 P.170



ergotron

Ergotron® Anti-Fatigue Floor Mats 防疲勞坐立地墊

人體工學設計產品
參考頁數 P.102



SIT. STAND. SWITCH.
健康建議!
每半小時轉換一吓坐立姿勢



人體工學及健康工作間

Ergonomic & Well Being Office

TruSens 防過敏及流感專業濾網



需要緩解過敏嗎？

過濾99%的致敏原



配合抗病毒的True HEPA濾網，能夠捕捉空氣中的致敏物和病毒，包括H1N1病毒

3重過濾

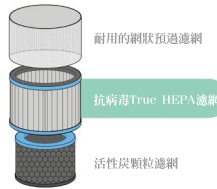

一體式的過濾系統由True HEPA高效空氣濾網、活性炭濾網和預過濾網組成

360° 高效濾網

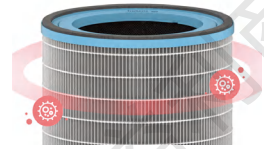

環形設計能夠全方位過濾房間四周圍空氣中的污染物

TruSens TruSens Air Purifier
TruSens UV 殺菌空氣淨化機

參考頁數 P.50



6大淨化功能

1 可清洗預過濾網*

- ✓ 阻隔毛髮
- ✓ 阻隔灰塵



2 活性炭濾網

- ✓ 去除異味
- ✓ VOC有機化合物 (包括甲醛/甲苯/清潔劑)



3 HEPA濾網

過濾PM2.5

- ✓ 細菌
- ✓ 病菌
- ✓ 致敏原 (包括花粉/塵蟎)



4 UV-C紫外光燈

殺滅吸附在濾網上

- ✓ 細菌
- ✓ 病菌
- ✓ 致敏原



5 SensorPod*無線遙距監控

- ✓ 自動監察空氣質量
- ✓ 13米無阻隔空間
- ✓ 放置在關注的位置 (如BB床邊)
- ✓ 以顏色顯示質量
- ✓ AQI國際標準質量數值



6 進行歐美地區測試*

- ✓ 歐洲防敏研究中心 (ECARF認證)
- ✓ UVC對人體有害的臭氣 (加州 CARB安全認證)



*適用於Z-2000及Z-3000型號

3款專業濾網

配合環境需要
自行另購專業濾網

1 寵物專業濾網

- ✓ 捕獲高達99.97%寵物皮屑及毛髮
- ✓ 消除一般寵物氣味



2 流感及致敏原專業濾網

- ✓ 捕獲高達99%致敏原
- ✓ 捕獲H1N1病毒

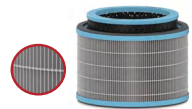

3 VOC除異味專業濾網

- ✓ 消除烹飪和清潔異味
- ✓ 消除VOC有機化合物異味

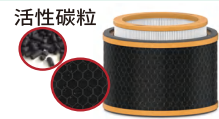



3M™ Lead Reduction Filtration System 3M™ 高流量除鉛濾水系統

- Reduce Lead up to 99.3%
- 0.2 micron rating
- NSF / ANSI Standard 42 & 53 certified
- Reduce Dust, Rust, Chlorine taste & odor, VOCs, Cysts
- Sanitary Quick Change design, allows for fast and easy cartridge change out with a ¼ turn
- Small foot print, matched with many water dispensers

參考頁數 P.16

配合不同三溫飲水使用

榮獲美國國家衛生基金會認證

NSF
NSF/ANSI Std. 42
感觀效應
NSF/ANSI Std. 53
健康效應



19

OASIS POLARIS座枱三溫水機

型號: POU1ACTHSKY



- 熱、室溫及冰水選擇功能
- 不銹鋼冷、熱水缸
- 供水: 冰水每小時5.1公升; 熱水每小時5.4公升
- 經EVERPURE 濾水設備接駁室內水管取水
- Size: W335 x D350 x H430mm

接管式座地三溫水機

型號: BYZ1171PP



- 熱、室溫及冰水選擇功能
- 不銹鋼冷、熱水缸
- 供水: 冰水每小時2公升; 熱水每小時5公升
- 外形美觀及出水位置方便
- 熱/冰水LCD水溫顯示
- 壓縮機冷卻
- 通過IEC安全測試及能源標籤認證(WD17-00001)
- Size: W310 x D340 x H1035mm

POU1ACTHSKY / BYZ1171PP

減用膠樽 · 使用3M™ 濾水系統

減少碳排放

為環境出一分力

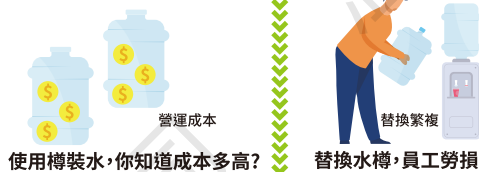

香港租金高, 樽裝水佔用空間



要記住訂水, 又要等水, 有冇想過有方法解決嗎?

3M™ 濾水系統 型號	方案一	方案二
		DWS160-L 高流量型濾水器
提供水機型號	POU1ACTHSKY / BYZ1171PP	POU1ACTHSKY / BYZ1171PP
國際認證	NSF/ANS 42 及 53	NSF/ANS 42 及 53
過濾精密度	0.2 微米	0.2 微米
有效過濾水量	6,000加侖 (22,712公升)	1,500加侖 (5,678公升)
流量	2.5加侖/分鐘 (9.4公升/分鐘)	0.6加侖/分鐘 (2.27公升/分鐘)
適用水壓	25-125psi	25-120psi
尺寸	H1.3 x W10.2 x D10.2cm	H41.6cm x W7.9.2 x D7.9cm
濾芯使用期	廠方建議為九至十二個月 但須視乎用水量和水质而定	廠方建議為九至十二個月 但須視乎用水量和水质而定
過濾物質	有效過濾沙石、鉛、鐵銹、餘氯、異味、重金屬、隱孢子蟲、細菌、及*揮發性有機化學物。 *揮發性有機化學物: 包括苯、對二氯苯、草脫淨、加保扶及林丹、農藥、殺蟲劑	NSF認證, 有效過濾水中平均99.3%鉛粒子及離子, 同時亦有效過濾水中鐵銹、餘氯、異味、沉積物、隱孢子蟲及細菌# #產品依照製造商實驗室的大腸桿菌ATCC (11229)標準進行測試。
	 隱孢子蟲 細菌 餘氯及異味	 隱孢子蟲 細菌 餘氯及異味
	 重金屬及鐵銹 沉積物 揮發性有機化學物	 重金屬及鐵銹 沉積物
	建議人數: 15-25	建議人數: 5-15

(濾水系統包一年上門清潔喉管及安裝保養)

2013
2019



國際培幼會

伊露 Y Loan
助養兒童

鄧麗欣 Stephy
國際培幼會榮譽大使

夢不應只是想

了解更多：



助養兒童 成就孩子夢想

☎ 3405 5305

🌐 plan.org.hk

📘 Plan Hong Kong

📷 planhk

REGISTRATION FORM

新客戶登記表 (FOR NEW ACCOUNT)



Hotline: (853)2871 9147

Fax: (853)2830 8886

E-mail: info@iatlei.com

Sales Representative 營業代表

ACCOUNT DETAILS 帳戶資料

Please complete all the fields in BLOCK LETTERS
請以正楷填寫所有資料

Company Name 公司名稱 _____

Business Registration No. 商業登記證號碼 _____
(Please submit a copy 請連同副本一份交回)

Year of Incorporation 成立年份: _____

Billing Address 帳戶地址 (English)

Flat/Unit Floor Building Street

(中文)

District 地域 _____ 澳門半島Macau 氹仔Taipa 路環Coloane

Delivery Address 送貨地址 (English)

(中文)

If different from Billing Address
如與帳戶地址相同, 不需填寫

Contact Person 收貨人 _____ (Mr / Miss) Tel 電話 _____ Fax 傳真 _____

A/C Department 會計部 _____ (Mr / Miss) Tel 電話 _____ E-mail 電郵 _____

Office Hours 辦公時間 (Mon-Fri) 星期一至五 _____ (Sat) 星期六 _____ (Lunch Hour) 午飯時間 _____

No of Employees in Your Office 職員人數 (1-10) (11-20) (21-50) (51-100) (101-200) (201-500) >500

Business Nature 業務性質

- | | | | | |
|--|---|--|---|--|
| 1 <input type="checkbox"/> Professional Consultant
專業顧問 | 5 <input type="checkbox"/> Charity
慈善 | 9 <input type="checkbox"/> Medical
醫療 | 13 <input type="checkbox"/> Food
食品 | 17 <input type="checkbox"/> Education
教育 |
| 2 <input type="checkbox"/> Entertainment
娛樂事業 | 6 <input type="checkbox"/> Media
媒體 | 10 <input type="checkbox"/> Chemical
化學 | 14 <input type="checkbox"/> shipping
船務 | 18 <input type="checkbox"/> Trading
貿易 |
| 3 <input type="checkbox"/> Building Construction
樓宇建造業 | 7 <input type="checkbox"/> Property
物業 | 11 <input type="checkbox"/> Public Utilities
公用事務 | 15 <input type="checkbox"/> Hospitality
款待 | 19 <input type="checkbox"/> Retail
零售 |
| 4 <input type="checkbox"/> Financial
金融業 | 8 <input type="checkbox"/> Consultant
顧問 | 12 <input type="checkbox"/> Electronic
電子 | 16 <input type="checkbox"/> IT
資訊科技 | 20 <input type="checkbox"/> Government
政府 |

Internet On-line Purchase Account 本公司希望申請網上訂購專戶  Yes 是 No 否

E-mail 電郵 _____

Receipt of Promotion Material 本公司希望和同意從以下途徑收取文儀產品的推廣及優惠資訊

Fax 傳真 E-mail 電郵 (Please specify 請注明)

Receipt of Statement 收取月結單形式

Electronic Statement (Free)
電子月結單(免費) By Fax (Free)
傳真(免費)

E-mail 電郵 _____ (有關戶口的登入及密碼會經由電郵發出)

Terms & Conditions 條例及細則

Date 日期 _____ Signature & Company Chop
簽名連同公司印鑑

- Details in application form must be the same as in the Business Registration.
- All account applications are subject to the final approval of IAT LEI.
- New accounts will have to settle payment by cash/cheque only.
- WizOffice reserves the right to charge 2% per month on overdue invoices.

- 以上所載資料須與商業登記證相同。
- 所有客戶批核以本公司最後決定為準。
- 新客戶需以現金/公司現票付款。
- 逾期帳單, 將會被收取2%月息。

For Official Use Only (只供本公司職員填寫)

Credit Facilities

Credit Limit _____ Payment Terms _____ Approved by _____

PB _____ Input by _____ Customer A/C Code _____

Invoice Type Immediate Monthly-30th Others: _____

Remarks _____ Date: _____

Order Form attached
附上訂貨表格

Yes 是 No 否

Already get office
supplies catalogue
已有文儀目錄冊

Yes 是 No 否



ORDER FORM

訂購表格

Hotline: (853)2871 9147
www.iatlei.com

Fax: (853)2830 8886

E-mail: info@iatlei.com

Order Date
訂購日期 _____

Account No.
客戶號碼 _____
Company Name
公司名稱 _____
Ordered by
訂貨人 _____

Salesmae
營業員 _____
Your PO.
採購單編號 _____
Direct line
直線電話 _____

Delivery Address
送貨地點 _____

Contact Person
收貨人 _____ Department
部門 _____ Direct line
直線電話 _____

Remarks
特別註明 _____

Product Code 貨品編號	Product Name 貨品名稱	Colour 顏色	Unit 單位	Quantity 數量	Unit Price 單價 MOP	Amount 總計 MOP
1						
2						
3						
4						
5						
6						
7						
8						
9						
10						
11						
12						

Please Note 請注意

- We accept M-Pay / cash. Crossed cheques should be made payable to "IAT LEI STATIONERY LTD".
本公司接受 M-Pay/現金。劃線支票抬頭註明溢利商業用品有限公司。
- All prices are marked in MOP.
所有貨品以澳門幣計算。
- Goods are sold by the units as specified.
訂購數量必須為銷售單位的倍數。
- Unused merchandise can be returned and exchanged within 7 days of the delivery date (except for special product).
Returned items must be included original packaging and accessories.
未經使用之貨品，可連同原箱包裝，於送貨後七天內辦理自攜退換(特價貨品除外)。
- Free delivery is offered for every order over MOP500 in Macau. For urgent items, please call (853) 2871 9131. We will arrange the delivery service as soon as possible.
澳門地區每次訂購滿MOP500即可享有免費送貨服務。如有特急件，請致電(853)2871 9131，我司將會盡快安排送貨服務。
- There is no choice of colour for items marked "Assorted Color".
All confirmation and price are subject to change according to final confirmation.
如貨品所示顏色為雜色，訂購時恕不可選擇顏色。產品資料及價格如有變動，以確認時為準。

Total Amount
總金額

Authorized Signature & Company Chop
簽名及公司印鑑



M-PAY 微信支付 支付宝

同心抗疫 · 快速測試

寶芝林新冠病毒快速抗原測試劑



單人份
獨立包裝



前鼻拭子套裝

通過多方**權威機構**認證
有效準確率達到**99.75%**
5分鐘內出檢測結果



20人份
包裝

通過美國FDA食品和藥物管理局認證
符合歐盟健康安全委員會標準
已獲德國衛生部回執
通過CE認證

