

桌面用品與印章

Desktop Products & Stamps

Magazing Rack	雜誌架	287
Book End	書立	288
Filing Cabinet	文件櫃	290
Document Tray	文件盤	291
Desk Organizer	文具組合盤	293
Pen Stand	筆筒	294
Cash Box	錢箱	294
Desk Mat	檯墊	294
Suggestion Box	意見箱	295
Key Holder	鎖匙箱 / 鎖匙簿	295
Name Card Cases & Book	名片盒 / 名片簿	296
Stamp Pads & Inks	印台及印墨	298
Numberators	數字印章	298
Dater Chop	日期印章	299
Dater Chop with Text	多用途日期印章	300
DIY Chop	字粒印章	300
Pre-inked Stamps	原子印章	301
Customize Pre-inked Stamps	訂造原子印章	302



15

桌面用品與印章
Desktop Products & Stamps

Miracle
Miracle Plastic Magazine Rack
雜誌架

Size : D246 x W85 x H295mm

- Grey ● 994 902102
- Black ● 994 902105
- Blue ● 994 9021025
- Green ● 994 9021045
- Red ● 994 9021075
- Yellow ● 994 9021095

UNIT Pc 24



Godex
Godex Plastic Magazine Rack
雜誌架

Size : D250 x W80 x H290mm

10色可選

- 黑
- 藍
- 灰
- 紅
- 綠
- 黃
- 橙
- 紫
- 淺灰
- 粉藍

UNIT Pc 32



SYSMAX
Sysmax Super Rack-2
雜誌架

36102, Size : D260 x W125 x H310mm

Grey

- 994 9031012
- Black
- 994 9031015
- Dark Blue
- 994 9031025

UNIT Pc Korea 20

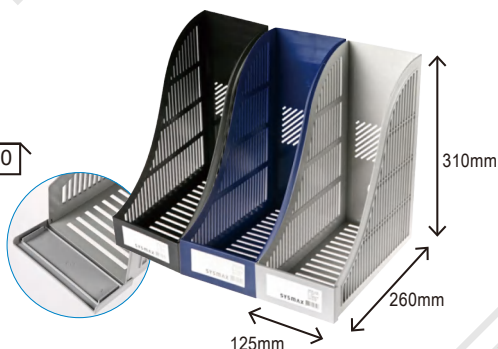

Mesh Wire Magazine File
網紋雜誌架

Size : D250 x W75 x H315mm

- 562 4112

UNIT Pc



Hius ZJ240 Paper Magazine File
可摺合紙質雜誌架

A4, Size : D255 x W100 x H300mm, 4"

- 994 9017

UNIT Pc 5

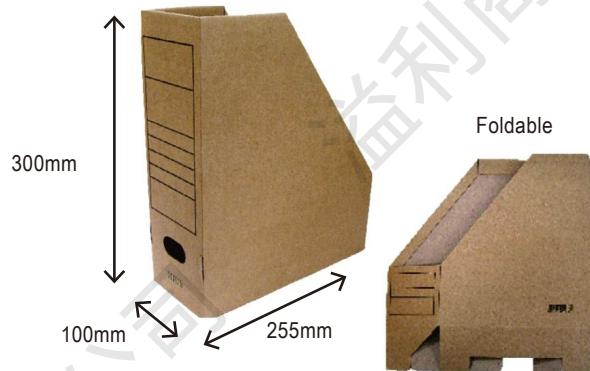

Godex
Godex Crystal Magazine File
透明雜誌架

GX-2019, Size : D240 x W90 x H275mm

Clear

- 074 9002089
- Blue
- 074 9002025
- Purple
- 074 9002065
- Orange
- 074 9002055
- Green
- 074 9002045

UNIT Pc 16

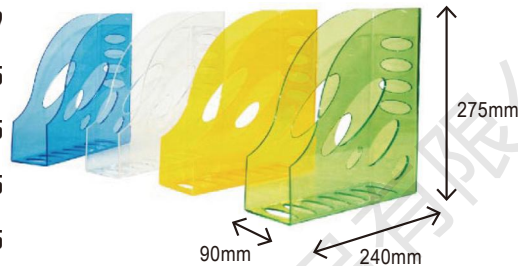

Bantex
Bantex Collapsible Magazine File
雜誌架

- PVC material, Collapsible
- 7 cm and 12cm spine magazine file with interchangeable spine label and finger hole
- Suitable for A5 size document
- 可摺合PVC雜誌架
- 厚度 7 厘米及 12 厘米可供選擇, 可存放A5尺碼之刊物及文件
- 脊位附圓形指孔及可放置索引的膠套。

Size : D250 x H315mm

UNIT Pc 25

Colour	Spine Width : 7cm		Spine Width : 12cm	
	Code	Model	Code	Model
● Grey	114 9001012	4010-05	114 9002012	4013-05
● Black	114 9001015	4010-10	114 9002015	4013-10
● Blue	114 9001025	4010-01	114 9002025	4013-01
● Cobalt Blue	114 9001026	4010-11	---	---
● Green	114 9001045	4010-15	114 9002045	4013-04
● Orange	114 9001055	4010-12	114 9002055	4013-12
● Red	114 9001075	4010-09	114 9002075	4013-09
● Yellow	114 9001095	4010-06	114 9002095	4013-06



SYSMAX

Sysmax 42116 Book Rack 3-Section

三格書立

- Can be stacked
- 可按需要加重量
- Size : D208 x W355 x H213mm
- Grey

• 994 9020012

UNIT Pc  12

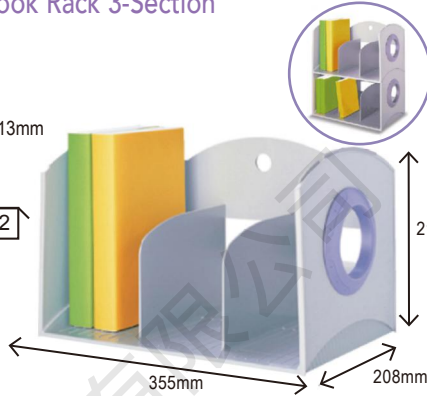

SYSMAX

Sysmax 42115 Book Rack 4-Section

四格書立

- Back panel for book standing
- 3 adjustable partition in 7 positions
- 背面附設擋板，固定書本，可放置適當深度
- 附三件間格板，可放置七個不同位置
- Size : D205 x W550 x H200mm
- Grey

• 994 9022012

UNIT Pc  12

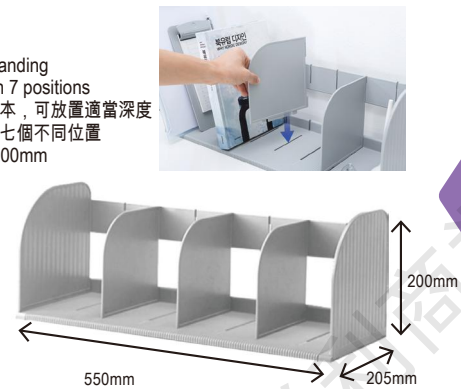

SYSMAX

Sysmax 42114 Book Rack 4-Section

四格書立

- Size : D210 x W450 x H210mm
- Grey

• 994 9013

UNIT Pc  8

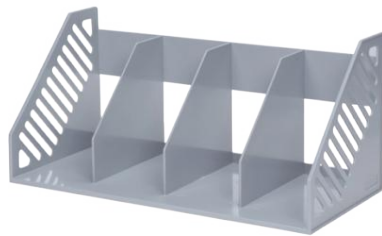

SYSMAX

Sysmax Book Rack

多用書架

- 42300, Size : D210 x W404 x H207mm
- Grey

• 994 9034012

White

• 994 9034085

UNIT Pc  4



Godex

Godex Book End

書立

- Angled book-ends keep books firmly in place
- Set of two ends made of heavy painted steel
- Assorted colour
- 承托力強，能固定書籍擺放位置
- 重金屬製造，每套兩個
- 雜色

- Size : L158 x W132 x H210mm
- Thickness : 1.1mm

UNIT Pair  80

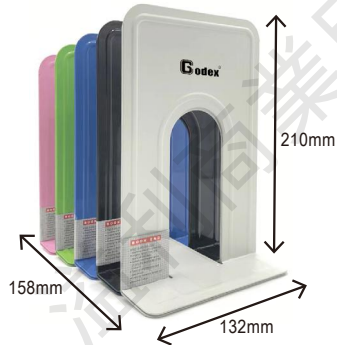

WIPAS
威帕斯

Godex Book End

加厚書立

- Angled book-ends keep books firmly in place
- Set of two ends made of heavy painted steel
- Black
- 承托力強，能固定書籍擺放位置
- 加厚金屬製造，每套兩個
- 黑色

- Size : L158 x W132 x H210mm
- Thickness : 1.7mm

UNIT Pair  80



SYSMAX

Sysmax Desk Multi Rack

座枱書架

- Removable Divider
- 可移除分格
- 33104, Size : D255 x W160 x H320mm
- Grey

• 994 9032012

Blue

• 994 9032025

UNIT Pc  12

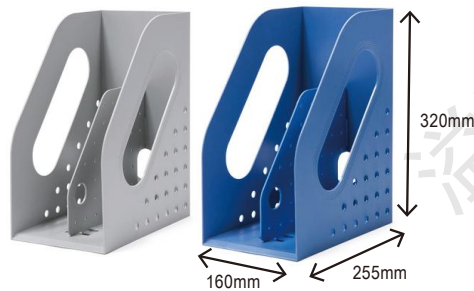

Mesh Wire Series

網紋系列

- Letter Grid
- 分類信格
- DL9176/NH-03, Size : D76 x W178 x H120mm
- Black

• 560 7002

UNIT Pc  12

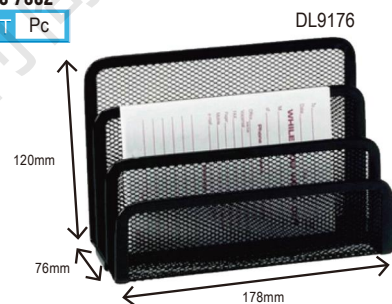

NEW ARRIVAL

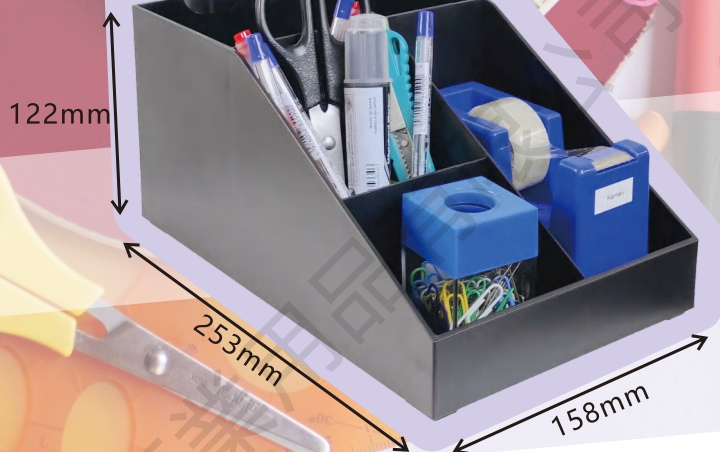

WPS-LZ706 文具收納盒

- 工程塑料材質輕便耐用
- 4格文具收納
- 淨重370g



WIPAS OFFICE SERIES 你的辦公好幫手

WPS-C905 文具收納盒



- 工程塑料材質輕便耐用
- 10格文具收納
- 淨重900g

YouTube



掃描查看WIPAS 2022Q2新品發佈

WPS-LZ703 5層文件櫃

- 工程塑料材質(淨重2.65kg)
- 可層疊起來, 方便慳位
- 底部附防滑膠墊



SYSMAX

Sysmax Deluxe Open File Cabinet

開放式文件櫃

13105, Size : D340 x W290 x H240mm
Frame colour
Blue

• 002 2065

UNIT Pc 



NCL Filing Cabinet

文件櫃

UNIT Pc



A4E-04B



A4E-05W



A4E-SK4B



A4E-04W



A4E-05B



A4E-SC6

Code	Model	Colour	No. of drawers	with Keylock	Size (D x W x H)mm
002 2048015	A4E-04B	Black	4	---	344 x 282 x 260
002 2048085	A4E-04W	White	4	---	344 x 282 x 260
002 2049015	A4E-05B	Black	5	---	344 x 282 x 260
002 2049085	A4E-05W	White	5	---	344 x 282 x 260
002 2050	A4E-SK4B	Black	4	✓	350 x 278 x 258
002 2051	A4E-SC6	Black	6	---	350 x 278 x 345

SYSMAX

Sysmax Filing Cabinet (with key lock)

文件櫃

UNIT Pc 



2880034



280031



280010



280012



280011

Code	Model	No. of drawers	Size(D x W x H)mm
002 2039012	280010	5	355 x 300 x 332
002 2039045	280011	5	355 x 300 x 332
002 2039025	280012	5	355 x 300 x 332
002 2039	280031	5	355 x 300 x 332
002 2042	280034	10	355 x 300 x 332

SYSMAX

Sysmax Sliding Living Box

趟拉式收納箱

68063, Size : D410 x W300 x H215mm
Ivory White

• 002 2076032

Grey

• 002 2076012

UNIT Pc 



SYSMAX

Sysmax System Multi Box - 9 drawers

零件櫃-9抽屜

57009, Size : D235 x W410 x H250mm
Frame colour
Mint

• 002 2069045

Grey

• 002 2069012

Yellow

• 002 2069095



Shuter

Shuter Filing Cabinet (P-Type)

文件櫃

- Metal case and Arylic drawers
- labelling clips
- 金屬外殼, 亞加力透明抽屜
- 附標籤

Drawer Size (P-Type) : D325 x W230 x H38mm

Code	Model	No. of drawers	Size(D x W x H)mm
902 2031	A4-103P	3	343 x 264 x 199
902 2005	A4-105P	5	343 x 264 x 287
902 2006	A4-106P	6	343 x 264 x 287
902 2001	A4-110P	10	343 x 285 x 483
902 2002	A4-112P	12	343 x 285 x 574
902 2050	A4-115P	15	343 x 285 x 740
902 2087	A4-230P	15 x 2	343 x 545 x 740

UNIT Pc



A4-103P



A4-105P



A4-106P



A4-110P



A4-112P



A4-115P



A4-230P



More sizes and models are available. Please contact our sales executive
另有其他尺碼供選擇不能盡錄, 詳情請向閣下的營業員查詢。

Shuter

Shuter Filing Cabinet (H-Type)

文件櫃

- Metal case and Arylic drawers
- labelling clips
- 金屬外殼, 亞加力透明抽屜
- 附標籤

Drawer Size (H-Type) : D325 x W230 x H79mm

UNIT Pc

Code	Model	No. of drawers	Size(D x W x H)mm
902 2081	A4-103H	3	343 x 264 x 287
902 2053	A4-105H	5	343 x 285 x 483
902 2029	A4-106H	6	343 x 285 x 574
902 2019	A4-109H	9	343 x 285 x 880
902 2091	A4-116H	16	343 x 285 x 1490
902 2039	A4-218H	9 x 2	343 x 545 x 880



Shuter

Shuter Filing Cabinet (Open Type)

開放式文件櫃

- Metal case and Plastic drawers
- labelling clips
- 金屬外殼, 塑膠抽屜
- 附標籤

Drawer Size (O-Type) : D328 x W230 x H37mm

UNIT Pc

Code	Model	No. of drawers	Size(D x W x H)mm
902 2006001	A4O-106P	6	343 x 264 x 287
902 2001001	A4O-110P	10	343 x 285 x 483
902 2002001	A4O-112P	12	343 x 285 x 574



DOCUMENT TRAY 文件盤

Godex

Godex Letter Tray 2-Deck

文件櫃

- For A4 documents. Can be stacked higher by using risers
- 適合擺放 A 4 之文件, 更可利用駁柱隨意增層數

Size : L335 x W255 x H60mm

Grey

• 997 7011012

Black

• 997 7011015

UNIT Set 24

Riser For Tray 4s

駁柱

4pcs/Set

• 997 7012 UNIT Set

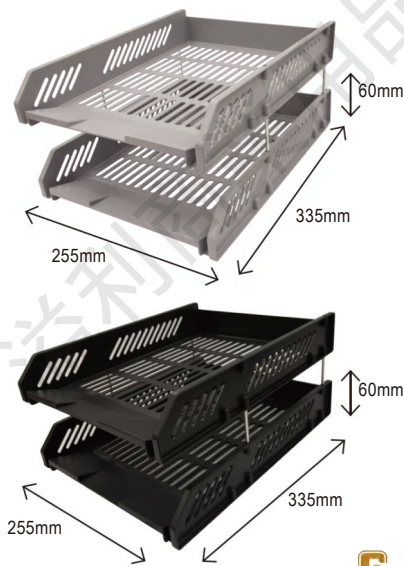

SYSMAX

Sysmax Super Neo Tray 3

三層文件盤

22137, Size : D336 x W263 x H240mm

Grey

• 007 7025012

Matt Clear

• 007 7025089

UNIT Set 24



SYSMAX

Sysmax Stackable Midas Tray

高式文件盤

22150, Size : D330 x W245 x H58mm

Black

• 007 7024015

White

• 007 7024085

UNIT Pc 12

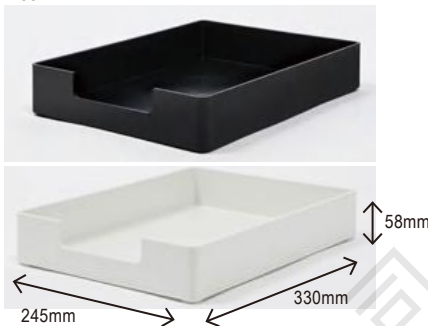

Godex

Godex Letter Tray (Horizontal) 2-Deck

橫開文件盤

GX-538, Size : D258 x W340 x H60mm

Black

• 077 7001015

Clear

• 077 7001089

UNIT Set 24

Riser For Tray 4s

駁柱

4pcs/Set

• 997 7012

UNIT Set

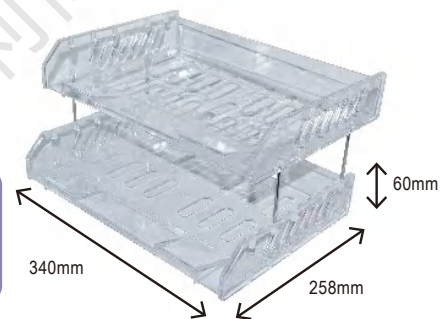

15

桌面用品與印章

Desktop Products & Stamps

304-15 Mutli Form Tray 2-Deck
多用途文件盤

- For F4 or A4 documents
 - High impact plastic, can be stacked
 - 適合擺放F4或A4之文件
- Size : L360 x W255 x H62mm

- 007 7001012
- Black
- 007 7001015

UNIT Set 12

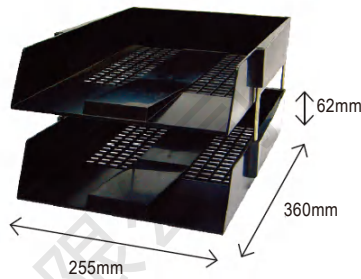

Riser For Tray 4s 駁柱
4pcs/Set
• 007 7003
UNIT Set

LEITZ®
Leitz 5226 Letter
Tray Plus 2-Deck
文件盤

Size : L357 x W255 x H70mm
Pearl White

- 207 7006085
- Pink
- 207 7006072
- Blue
- 207 7006025
- Orange
- 207 7006055
- Green
- 207 7006045

UNIT Set 24

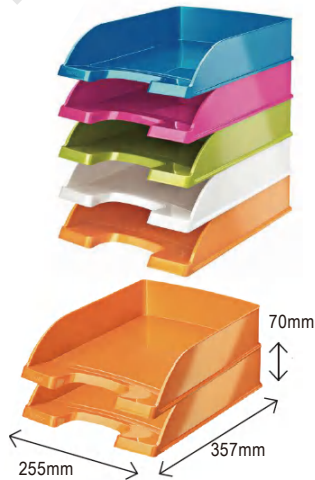

M&G
M&G Storage Basket
晨光收納籃

ADM95084, B5
• 997 7014
ADM95083, A4
• 997 7015

UNIT Pc 24



Mesh Wire Partition
Basket
網紋掛屏風式文件籃

Hanging Basket
Size : L390 x W90 x H185mm
White

- 007 7014085 **NEW**
- Black
- 007 7014
- Corner Triangle Basket
- Size : L280 x W280 x H50mm
- 007 7015

UNIT Pc



Crystal Letter Tray 2-Deck
透明文件盤

Size : L330 x W240 x H53mm

- Blue
- 997 7006025
- Purple
- 997 7006065
- Clear
- 997 7006089

Riser For Tray 4s 駁柱
4pcs/Set
H60mm
• 997 7002
UNIT Set

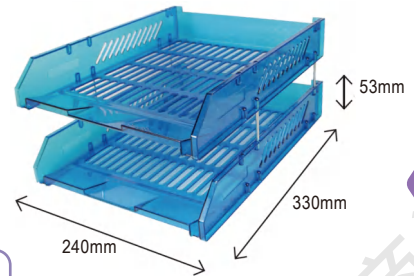

Mesh Wire Tray
網紋文件盤

9183
Size : L360 x W274 x H185mm
2-Deck 兩層

- 562 4113
- ADM94754
- Size : L350 x W297 x H275mm
3-Deck 三層
- 562 4111

UNIT Set

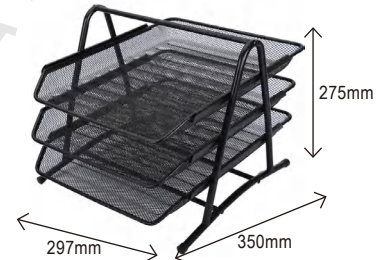
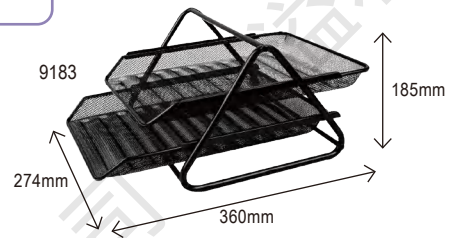

321/333 Acrylic 2-Deck Tray
亞加力膠文件盤

- Made of acrylic plastic, smoky colour, 2 trays per set
 - 茶色亞加力膠雙層文件盤
- Size : L355 x W257 x H50mm
Smoky

007 7002

UNIT Set 12

#321-323 Riser 駁柱
4pcs/Sets
• 007 7007
UNIT Set



Mesh Wire Shelf Hanging Basket
網紋掛桌/層板文件籃

Size : L370 x W240 x H105+33mm
L

- 007 7016
- Size : L305 x W255 x H100+25mm
S
- 007 7017

UNIT Pc



15

桌面用品與印章

Desktop Products & Stamps

15

桌面用品與印章
Desktop Products & Stamps

3M

3M C-71 Post-it® Desk Drawer Organizer

報事貼®書桌抽屜文具組合盤

- Adjustable width to fit drawers of different size
- Includes Post-it® 3 x 3 Notes, and Flags, as well as Scotch® Tape
- 收納日常應用文具於抽屜內
- 文具盤之寬度可隨意調校，適合不同的抽屜間格
- 內含報事貼®便條紙1本、報事貼®旗仔2個及思高®牌膠紙1卷
- 100% 可回收再造

Size : D267 x W298 x H41mm

• 017 7002

UNIT Pc



3M

3M C-50 Post-it® Desktop Organizer

報事貼®桌面文具組合座

- Includes Post-it® 3 x 3 Notes, and Flags, as well as Scotch® Tape
- 特有加重底座，不易移動
- 可整合您的桌面，收納各式文具。減少凌亂
- 內含報事貼®便條紙1本、報事貼®旗仔2個及思高®牌膠紙1卷

Size : D171 x W260 x H70mm

• 017 7004

UNIT Pc



SYSMAX

SYSMAX Desk Organizer

多用途桌上文具盤

42106, Size : D120 x W530 x H70mm

Dark Grey

• 007 7026015

White

• 007 7026085

UNIT Pc



Golden Horse Elegant Stationery Set

BWW-05, Wood with Black mesh metal 5 in 1

• 992 4026

BWAH-05(R), Red wooden with Silver metal

UNIT Set



BWW-05

M&G

M&G Mesh Desk Holder

晨光金屬網狀文具組合座

ABT98405

Size : D105 x W200 x H100mm

Black • 002 4002170

UNIT Pc



SYSMAX

SYSMAX Multi Storage

多用途分類盤

68020, Size : D173 x W330 x H136mm

Grey

• 992 4046012

Ivory White

• 992 4046032

UNIT Pc 12



Desk Holder

桌上文具組合座

GX-97, Size : D130 x W157 x H100mm

Clear

• 071 8001

GX-98, Size : D109 x W150 x H100mm

Clear

• 071 8002

UNIT Pc 60

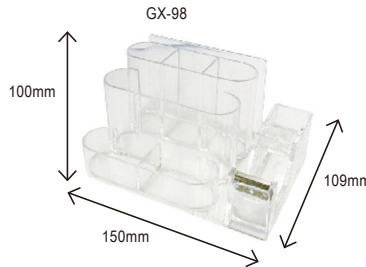
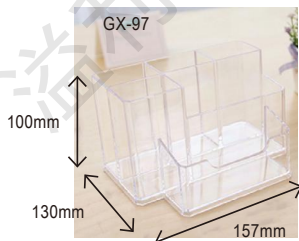

SYSMAX

SYSMAX Desk Organizer

多用途桌上文具盤

- 4個不同大小的儲存隔間
- 適合存放細小文具、計數機、藥品、化妝品或電話等
- 北歐色系，簡約時尚
- (韓國製造)

46117, Size : D110 x W205 x H112mm

Grey • 007 7108012

Blue • 007 7108025

Green • 007 7108045

Orange • 007 7108055

UNIT Pc NEW



SYSMAX

SYSMAX Desk Organizer

多用途桌上文具盤

- 多格設計方便不同用品收納，如小文具、拍紙簿、飾物、手機、化妝或其他雜物等
- 活動式間隔設計，可調節大小
- 附有手抽位，易於攜帶或移動
- (韓國製造)

270036, Size : D130 x W340 x H180mm

Matt Clear

• 007 7107

UNIT Pc NEW



PEN STAND 筆筒

Mesh Wire Pen Holder
金屬網狀筆筒

ABT-98401, Size : D74 x W74 x H115mm
Square shape 四方形
● 562 4001
ABT-98403, Size : ø85 x H105mm
Round shape 圓形

● 562 4002

UNIT Pc



Pen Holder
筆筒

Size : Ø79 x H100mm
Grey

● 002 4002012
Black

● 002 4002015
Smoky

● 002 4002033

UNIT Pc 60



15

CASH BOX 錢箱

Carl Cash Box
錢箱

CB-8100, Size : L129 x W152 x H83mm

● 132 2001

CB-8200, Size : L155 x W195 x H86mm

● 132 2003

CB-8300, Size : L162 x W197 x H86mm

● 132 2008

CB-2010, Size : L170 x W250 x H84mm

● 132 2011

CB-D8760, Size : L286 x W352 x H145mm

● 132 2009

UNIT Pc



※ 密碼及鎖匙

SR Cash Box
錢箱

SR11, Size : D123 X W158 x H75mm
Blue

● 432 2040025

Red

● 432 2040075

SR15, Size : D123 x W158 x H75mm,
With tray
Blue

● 432 2039025

Red

● 432 2039075

UNIT Pc

SR18, Size : D145 x W200 x H77mm
Blue

● 432 2038025

Red

● 432 2038075

CB2010N, Size : L230 x W185 x H80mm, 10"

● 432 2036

CB2012N, Size : L300 x W230 x H80mm, 12"

● 432 2037



※ 密碼及鎖匙

DESK MAT 檯墊

Bantex Desk Mat
檯墊

- Transparent desk pads
- Made from heavy anti-glare plastic
- 透明辦公桌墊
- 由防反光塑料製成

UNIT Pc

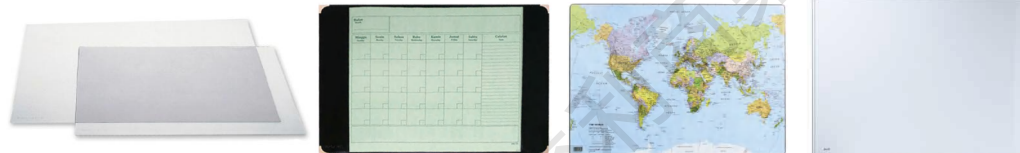

#4121 / #4122

#7460

#4150

#4172

#4121
Size : L390 x W580mm
Matt Clear
磨砂

● 113 1006

#4122
Size : L490 x W650mm
Matt Clear
磨砂

● 113 1007

#7460
Size : L460 x W630mm
With Blotting Paper
檯墊連吸墨紙

● 113 1005

#4150
Size : L440 x W630mm
With World Maps
世界地圖檯墊

● 113 1001

#4172
Size : L490 x W650mm
Glass Clear
光面

● 113 1003

桌面用品與印章

Desktop Products & Stamps

**Steel Multi-Purpose Deposit Box
不銹鋼意見箱**

- Tough steel construction, ideal as return deposit box, an internal / external post box or suggestion box
- Complete with 2 keys and wall mounting kit & label set
- 堅固鋼材, 可用作回收箱、出/入郵件箱或意見箱等
- 附上鑰匙2條

2104, Size : D110 x W210 x H270mm

• 990 8114

2604, Size : D125 x W260 x H340mm

• 990 8115

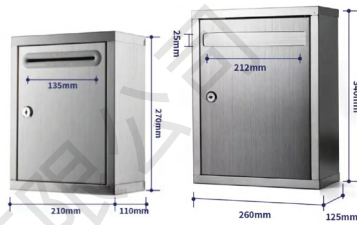

**Helix Multi-Purpose Deposit Box
多用途安全箱**

- Tough steel construction, ideal as return deposit Box, an internal / external post Box or suggestion Box
- Complete with 2 keys and wall mounting kit & label Set
- 堅固鋼材, 可用作回收箱、出/入郵件箱或意見箱等
- 附上鑰匙2條、掛牆附件及標籤

W50010, Size : D85 x W220 x H320mm

• 110 8010



15

桌面用品與印章
Desktop Products & Stamps

KEY HOLDER 鎖匙箱、鎖匙簿

**Helix Combination key safes
密碼鎖鎖匙箱**

520511, Size : D70 x W224 x H205mm, 50Key
Black

• 110 8021

521111, Size : D70 x W315 x H400mm, 100Key
Black

• 110 8022

521551, Size : D80 x W320 x H410mm, 150 key
Black

• 110 8023



**Helix Standard Keysafes
鎖匙箱**

- Metal key hangers for use with most key tags, durable metal construction with strong cylinder lock with two keys
- Includes wall fixing kit, index sheets, key labeling kit and a pack of the required key fobs
- 金屬掛勾附標籤位置, 金屬結構鎖頭連鑰匙2條

Code	Model	Capacity	Size(D x W x H)mm
110 8020	520110	10 keys	45 x 225 x 110
110 8018	520210	20 keys	45 x 225 x 110
110 8019	520310	30 keys	45 x 225 x 205
110 8014	520510	50 keys	70 x 225 x 205
110 8012	520710	70 keys	70 x 225 x 205
110 8013	521110	100 keys	70 x 310 x 400
110 8015	521550	150 keys	70 x 310 x 400
110 8016	522210	200 keys	70 x 310 x 400
110 8017	523310	300 keys	70 x 620 x 400

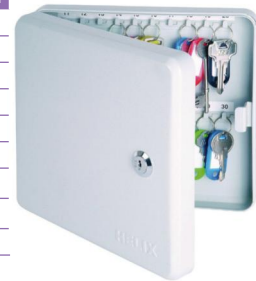

MIT

**MIT Key Holder
鎖匙簿**

- With index paper for classification
- Capacity of 72 keys
- 附索引標籤, 方便分類
- 可存放72條鎖匙

Size : L250 x W260mm
Black

• 560 8001



**Globe 201 Key Holder
鎖匙簿**

- To hold key securely in a ring binder
- 內附6張活頁可存放72條鎖匙

Inner pocket size : W43 x H72mm

Black

• 990 8001015

Blue

• 990 8001025

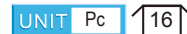

Key Holder Refill
6 sheets/Pad

• 990 8007

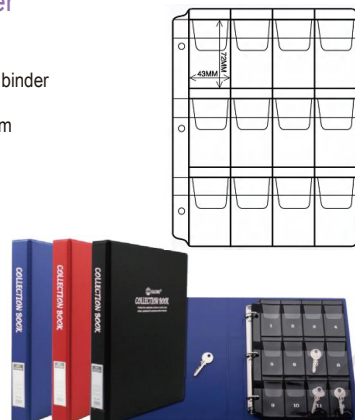

**Jielisi Key Box
鎖匙箱**

8703, Size : D52 x W265 x H490mm, 48key

• 990 8014

8704, Size : D52 x W380 x H450mm, 72key

• 990 8009

8705, Size : D52 x W380 x H590mm, 96key

• 990 8103



**Key Tag Translucent Colour
鎖匙牌**

- Colour key plate
- 顏色鎖匙牌

B1005





50pcs/Box

• 990 8068





Godex Name Card Stand
名片座

- GX-040
● 078 2465 
GX-52, 1-layer
● 078 2469 
GX-53, 2-layer
● 078 2467 
GX-54, 3-layer
● 078 2468 

UNIT Pc

GX-040



GX-052



GX-053



GX-054

15



Godex Refillable Name Card Book
活頁名片簿

- GX-LP400, 400 pockets
Black
● 078 2001015
Blue
● 078 2001025
GX-LP600, 600 pockets
Black
● 078 2002015
Blue
● 078 2002025

UNIT Pc

Refill 名片簿替芯
10 Sheets / Pad

- 078 2003
UNIT Pad 



A&B Name Card Book
名片簿

Size : L198 x W110 mm



Colour	# NC-120 120 Pockets	#NC-240 240 Pockets
● Grey	998 2063012	998 2064012
● Black	998 2063015	998 2064015
● Blue	998 2063025	998 2064025

UNIT Pc 

DataBank Name Card Book
名片簿

- 360 pockets
Black
● 178 2003015
Blue
● 178 2003025

UNIT Pc 



KING JIM

King Jim MEQRU Name Card Scanner
數碼名片簿

- 3 steps to scan your name cards. Rotary control
- Easy way to find name card without use your Pc
- 3個步驟，由旋轉式操作按鈕控制
- 無須接上電腦，快速查閱找尋名片

MQ10

- 418 2013

UNIT Pc



Colour	顏色	Black and orange
Display	屏幕	3.5" (TFT LCD) HVGA(320x480)
Scan area	掃描尺寸	Approx. 54mm x 90mm
Scan thickness	掃描厚度	0.43mm (max.)
Dimension	尺寸	D123 x W139 x H129mm
Weight	重量	325g
Storage	儲存	Single Side: Approx. 5000sheets (92kb) Double Side: Approx. 2500 sheets
System support	系列要求	Windows10/ 8.1/8/7/Vista Mac OS X 10.9/10.8/10.7

KW Name Card Case
名片盒

- Metal construction card file with smoke-color plastic lid
 - 鐵盒配煙燻黑色膠蓋
- 440, Size : L158 x W105 x H82mm, 400 cards
● 728 2001
460, Size : L215 x W105 x H82mm, 600cards
● 728 2002
480, Size : L272 x W105 x H82mm, 800cards
● 728 2003

UNIT Pc 



Carl Name Card Case
名片盒

- Popular and useful tool in keeping name cards
- Index A-Z for easy identification
- 方便儲存咭片
- 附A-Z索引咭分隔

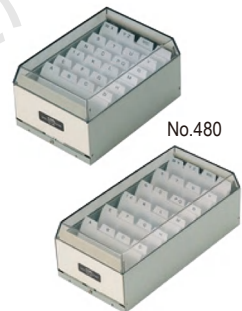

Code	Model	Card Capacity	Size (L x W x H)mm	Weight
138 2001	No.480	400 cards	145 x 103 x 75	380g
138 2002	No.600	600 cards	205 x 103 x 75	470g

UNIT Pc 

桌面用品與印章

Desktop Products & Stamps



Your Business Partner

德士美 好幫手



Artline

Artline Stamp Pad
印台

- Metal Case
- 金屬外殼

UNIT Pc



Color	No.00, Size : 40 x 63mm	No.0, Size : 56 x 90mm	No.1, Size : 67 x 106mm	No.2, Size : 87 x 143mm
Black	067 0004015	067 0001015	067 0002015	067 0003015
Blue	067 0004025	067 0001025	067 0002025	067 0003025
Red	067 0004075	067 0001075	067 0002075	067 0003075
Unlinked	067 0006	---	067 0005	067 0003

Horse Stamp Pad
印台

金屬外殼 Metal Case
Size : 65 x 95mm
Black

- 997 0007015 Blue
- 997 0007025 Red
- 997 0007075

UNIT Pc



15

Stamp Pad Ink
印台油

24ml
Black

- 998 8003015
- Blue
- 998 8003025
- Red
- 998 8003075

UNIT Bottle



Deskmate

Deskmate Stamper Ink
原子印油墨

10ml
Black

- 418 8001015 Purple
- 418 8001065
- Blue
- 418 8001025 Red
- 418 8001075
- Green
- 418 8001045

UNIT Bottle 24



Lion Number Machine Ink
跳字油墨印機專用墨水

28g
Black

- 428 8001015
- Blue
- 428 8001025
- Red
- 428 8001075

UNIT Bottle 12



Artline

Artline Stamp Pad Ink
印台油

ESA-2N, 50ml
Black

- 068 8003015
- Blue
- 068 8003025
- Green
- 068 8003045

UNIT Bottle 12



Artline

Artline X-Stamper Ink
原子印油墨

CS-10, 10ml
Black

- 068 8001015
- Blue
- 068 8001025

UNIT Bottle 12



XStamper Secure Stamper Ink
保密印章油墨

CLR-10N, 10ml
Black

- 068 8006

UNIT Pc 12



NUMBERATORS 數字印章

Deskmate

Deskmate Automatic Numbering Machine
自動跳數機

- Self-inking
- Choices of 1,2,3,4,5,6,12 times repeat
- 自動上墨

Code	Model	Descriptions
411 3001	05006	6-digits
411 3002	05007	7-digits
411 3006	05008	8-digits
411 3003	05009	9-digits
411 3004	05012	12-digits

UNIT Pc 50



Max Automatic Numbering Machine
自動跳數機

- Self-inking
- choices of 1,2,3,4,6,12 times repeat; maximum of 10 digits
- 自動上墨
- 可選1,2,3,4,6或12重打次數; 最多10位數字
- N504, 5-Digit
- N807, 8-Digit
- 521 3002
- 521 3006
- N607, 6-Digit
- N1203, 12-Digit
- 521 3005
- 521 3013

UNIT Pc 50



Max Refill Pad for Numbering Machine
自動跳數機墨墊

- NR50400 F/504
- NR10400 F/607
- 521 3009504
- 521 3009
- NR50400 F/807
- 521 3014



15

桌面用品與印章
Desktop Products & Stamps



Deskmate RP-1822 Self-Inked Dater Chop
自動上墨日期印

- Easy and handy, Self-inking stamp
- Replacement ink pad available
- 自動上墨日期印, 輕巧方便
- 可更換墨墊

D3, 3mm
Black

• 411 4030015

Blue

• 411 4030025

Red

• 411 4030075

D4, 4mm
Black

• 411 4031015

Blue

• 411 4031025

Red

• 411 4031075

UNIT Pc 6

25 FEB 2012
30mm x 3mm

25 FEB 2012
40mm x 4mm

Ink Pad Refill For D3,D4
Black

• 417 0001015

Blue

• 417 0001025

Red

• 417 0001075

UNIT Pc



XStamper Secure Stamper
保密印章

- Protect yourself with special black ink obscures private information and is perfect for hiding personal data on mail and in documents. Covered information can not be easily read, scanned or copied
- 保護私隱特製黑色油墨能模糊私人資料及隱藏個人資料在郵件或打印的文件上, 油墨所覆蓋的資料不輕易經複印或掃描得到

ES-BS, 13 x 42mm

• 061 4009

ES-2S, 24 x 71mm

• 061 4010

UNIT Pc

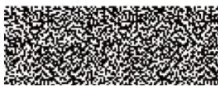

Trodat Self-inked Dater Chop
日期印

- Self-inking stamp
- Replacement ink pad available
- 無需使用印台
- 可更換墨墊

4810, 3mm
Black

• 871 4004015

Blue

• 871 4004025

Red

• 871 4004075

UNIT Pc 10

4mm, 4820
Black

• 871 4005015

Blue

• 871 4005025

Red

• 871 4005075

UNIT Pc 10

Ink Pad Refill

墨墊

Black

• 871 4008015

Blue

• 871 4008

Red

• 871 4008075

UNIT Pc

Ink Pad Refill

墨墊

Black

• 871 4010015

Blue

• 871 4010

Red

• 871 4010075

UNIT Pc



17 AUG 2018
20mm x 3mm



17 AUG 2018
20mm x 4mm



XStamper Line Dater Chop
日期印

CD-AN(5212) No.1

Blue

• 061 4002025



31 DEC 2015



Deskmate Multi-function Stamp (3mm)
多用途回墨印章

UNIT Pc

12

Shiny S-70 Multi-Function Chop
多用途日期膠印

- Select the phrase and Set the number
- 11 types of pre-defined texts for choice
- 可選擇十一種不同詞組
- 配合適當日期使用

• 711 4002

UNIT Pc



Deskmate Date Chop
日期膠印

- Light and handy
- English layout with clear impressions
- 英文日期
- 輕巧兼印字清晰, 使用方便

00403, 3mm,

• 411 4035

00404, 4mm

• 411 4036

00405, 5mm

• 411 4037

UNIT Pc

12

3mm 25 FEB 2012

4mm 25 FEB 2012

5mm 25 FEB 2012



SD-2156A

SD-2156B

SD-2156C



Deskmate SD-2156 Ink Pad Refill

墨墊

Blue/Red

• 417 0003

Blue

• 417 0004

UNIT Pc

- 1 P A I D 7 APPROVED
- 2 E-MAILED 8 OVERDUE
- 3 U R G E N T 9 R E V I S E D
- 4 C A N C E L L E D 10 S H I P P E D
- 5 F A X E D 11 C H E C K E D
- 6 R E C E I V E D 12 C O M P L E T E D

A SHIPPED 25 FEB 2012

B 25 FEB 2012 - 28 FEB 2012

C 1 2 3 4 5 6 7 8 9 0 1 2 3

trodat

Trodat 4750 Self-Inked Dater Chop With Text 多用途日期印

- Self-inking dater surrounding by a plate with text
- Integral ink pad with blue/red ink
- Replacement ink pad is available
- 日期連字印章
- 紅及藍雙色墨水，可更換墨墊
- 印字尺碼：41 x 24 毫米

L1, <Received>

- 871 4003
- L2, <Paid>
- 871 4002
- L9, <Faxed>
- 871 4001

UNIT Pc 10

Trodat 4750 Ink Pad Refill
墨墊
Blue/Red
• 871 4009 UNIT Pc



L1



L2



L9

Deskmate

Deskmate Dater Chop With Text 日期膠印

- Stamp with text surrounding the date
- 預設字樣連日期
- 字體尺碼：27 x 47毫米

- 00435 <RECEIVED>
- 411 4043
- 00437 <PAID>
- 411 4045

UNIT Pc 50

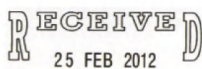

00435

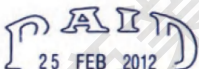

00437

Deskmate

Deskmate Self-Inked Dater Chop With Text 多用途日期印章

- Self-inking dater surrounding by a plate with text
- Integral ink pad with blue/red ink
- replacement ink pad is available
- 日期連字印章
- 紅及藍雙色墨水，可更換墨墊
- 印字尺碼：41x 24 毫米

Deskmate
RP-2441 Ink Pad Refill
墨墊
Blue/Red
• 411 4006
UNIT Pc



15

RP-2441, 4mm

L1, <PAID> L4, <APPROVED>

- 411 4038
- 411 4041

L2, <RECEIVED> L5, <ENTERED>

- 411 4039
- 411 4042

L3, <FAXED>

- 411 4040

UNIT Pc 6



BY:.....

BY:.....

L1

L2



BY:.....

BY:.....

BY:.....

L3

L4

L5

Shiny R-542D-T24 Dater Chop With 24 Hours 多用途日期印

- 24 Hours format with received message
- 2 colours date chop
- 24小時調校，received字樣日子印章
- 圓印直徑：41毫米
- 雙色時間日期印

<Received>

- 771 4040

UNIT Pc



DIY CHOP 字粒印章

Shiny S-421 Self Inking Dater DIY Chop Kit 多用途組合式上墨日期印

4mm, Black/Red

- 771 4052

UNIT Set

Ink Pad Refill
墨墊
S400-7D
Blue/Red
• 771 4025
Black/Red
• 771 4018

UNIT Pc 12



Toyoda Multi-Join Chop 字粒膠印

- Easy-to-assemble in horizontal and vertical arrangement according to your preference
- 容易合併，可直和橫放，方便使用

UNIT Set 12

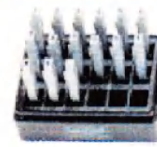

code	Model	Descriptions	Height
991 4001	No.4	Number Joint 數字組合	4mm
991 4002	No.5	Number Joint 數字組合	3mm
991 4003	No.4	Alphabetical Joint 字母組合	4mm

桌面用品與印章

Desktop Products & Stamps



Deskmate Stamper

原子印

- Over 3,000 categories, Ink-refillable. Special Combine-together function for desktop convenience
- 超過三百多款印匯，可無限次加墨循環再用，組合式印盒，整齊方便

UNIT Pc 12



FULL SIZE SAMPLE 實物原始大小參考

15

English Category

英文字

Desktop Products & Stamps 桌面用品與印章

AIR MAIL KE-A01 • 411 4001A01	AIR MAIL KE-A01B • 411 4001A1B	APPROVED KE-A02 • 411 4001A02	A/C PAYEE ONLY KE-A04 • 411 4001A04	AMENDMENT KE-A05 • 411 4001A05	APPROVED KE-A06 • 411 4001A06	APPROVED FOR PAYMENT KE-A07 • 411 4001A07	BY HAND KE-B01 • 411 4001B01
BY HAND KE-B01A • 411 4001B1A	BY COURIER KE-B03 • 411 4001B03	BY FAX KE-B05 • 411 4001B05	COPY KE-C01 • 411 4001C01	COPY KE-C01A • 411 4001C1A	C.O.D. KE-C02A • 411 4001C2A	CREDIT KE-C03 • 411 4001C03	CONFIRM KE-C04 • 411 4001C04
CONFIRMATION KE-C05 • 411 4001C05	COMPLETED KE-C06 • 411 4001C06	CHECKED KE-C07 • 411 4001C07	CASH KE-C08 • 411 4001C08	CANCELLED KE-C10 • 411 4001C10	CANCELLED BY DATE KE-C10A • 411 4001C0A	COMPLETED BY DATE KE-C06B • 411 4001C6B	CONFIDENTIAL KE-C11 • 411 4001C11
CERTIFIED BY KE-C16 • 411 4001C16	CERTIFIED TRUE COPY KE-C17 • 411 4001C17	CHECKED DATE BY KE-C19 • 411 4001C19	CIRCULAR KE-C21 • 411 4001C21	CLOSED KE-C23 • 411 4001C23	DUPLICATE KE-D01 • 411 4001D01	DUPLICATE KE-D01A • 411 4001D1A	DRAFT KE-D02 • 411 4001D02
DRAFT KE-D02A • 411 4001D2A	DO NOT BEND KE-D03 • 411 4001D03	DELIVERED DATE: KE-D05 • 411 4001D05	EXPRESS KE-E01 • 411 4001E01	ENTERED DATE: KE-E02 • 411 4001E02	ENTERED DATE BY KE-E06A • 411 4001E6A	ENTERED DATE BY KE-E07 • 411 4001E07	EMAIL OUT KE-E12 • 411 4001E12
EXPIRED KE-E13 • 411 4001E13	FILE KE-F02A • 411 4001F2A	FAX OUT KE-F06 • 411 4001F06	FAXED DATE: KE-F07 • 411 4001F07	FILE COPY KE-F08 • 411 4001F08	FAXED KE-F12 • 411 4001FF2	FAXED KE-F12A • 411 4001F12	FOR INFORMATION ONLY KE-F14 • 411 4001F14
FOR RECORD ONLY KE-F15 • 411 4001F15	FAX KE-F16 • 411 4001F16	FOR REFERENCE ONLY KE-F21 • 411 4001F21	HOLD KE-H01 • 411 4001H01	THE GOVERNMENT OF THE HKSAR KE-H02B • 411 4001H2B	NON NEGOTIABLE A/C PAYEE ONLY KE-N01 • 411 4001N01	NOT NEGOTIABLE A/C PAYEE ONLY KE-N02 • 411 4001N02	OUT KE-O01 • 411 4001O01
ORIGINAL KE-O02 • 411 4001O02	ORIGINAL KE-O02A • 411 4001O2A	OK KE-O04 • 411 4001O04	PAID KE-P01 • 411 4001P01	PAID KE-P01A • 411 4001P1A	PAID KE-P01B • 411 4001P1B	POSTED DATE: KE-P04 • 411 4001P04	POSTED DATE KE-P04A • 411 4001P4A
PERSONAL KE-P05 • 411 4001P05	PLEASE FOLLOW UP KE-P08 • 411 4001P08	PAID DATE: KE-P09 • 411 4001P09	PRIVATE & CONFIDENTIAL KE-P10 • 411 4001P10	PAID CASH KE-P17 • 411 4001P17	POSTED KE-P20 • 411 4001P20	PAID DATE CHQ. NO. KE-P26 • 411 4001P26	QUOTATION KE-Q01 • 411 4001Q01
RECEIVED KE-R01 • 411 4001R01	RECEIVED KE-P01A • 411 4001R1A	RECEIVED KE-R01B • 411 4001R1B	RECEIVED DATE: KE-R02 • 411 4001R02	REGISTERED KE-R03A • 411 4001R3A	REMINDER KE-R04 • 411 4001R04	REMINDER KE-R04A • 411 4001R4A	REVISED KE-R06 • 411 4001R06
REFERENCE NO. KE-R07 • 411 4001R07	RECEIVED DATE/BY KE-R08 • 411 4001R08	RECEIVED DATE KE-R08A • 411 4001R8A	RESEND KE-R09A • 411 4001R9A	RESEND DATE KE-R09B • 411 4001R9B	REFAX KE-R10 • 411 4001R10	REJECTED KE-R11 • 411 4001R11	RESTRICTED KE-R13 • 411 4001R13
SAMPLE KE-S01 • 411 4001S01	SHIPPED KE-S05 • 411 4001S05	SUPERSEDED KE-S09 • 411 4001S09	SENT KE-S13 • 411 4001S13	TRANSFER FROM TO: KE-T04 • 411 4001T04	TO BE OPENED BY ADDRESSEE ONLY KE-T07 • 411 4001T07	URGENT KE-U01 • 411 4001U01	URGENT KE-U01A • 411 4001U1A
URGENT! PLEASE KE-U02 • 411 4001U02	VOID KE-V01 • 411 4001V01	VERIFIED BY: KE-V02 • 411 4001V02	KE-U01 KE-U01 • 411 4001KU1	KE-U02 KE-U02 • 411 4001KU2			

English Two Colours Category

英文字(雙色)

VIA AIR MAIL KE-A01A • 411 4001A1A	APPROVED KE-A06A • 411 4001A6A	COPY KE-C01B • 411 4001C1B	COMPLETED KE-C06C • 411 4001C6C	CANCELLED KE-C10C • 411 4001C0C	CONFIDENTIAL KE-C11A • 411 4001CCA	E-MAILED KE-E01A • 411 4001E1A	FAXED KE-F07A • 411 4001F7A
FILE COPY KE-F08A • 411 4001F8A	POSTED KE-P02B • 411 4001P2B	RECEIVED KE-R02A • 411 4001R2A	REVISED KE-R06A • 411 4001R6A	SAMPLE KE-S01A • 411 4001S1A	URGENT KE-U01B • 411 4001U1B	VOID KE-V01A • 411 4001V1A	PLEASE NOTE KE-U03 • 411 4001KU3
							PLEASE NOTE KE-U04 • 411 4001KU4

Chinese and English Category

中英文字

收訖 RECEIVED KEC-310 • 411 4003310	已修訂 REVISED KEC-313 • 411 4003313	作廢 CANCELLED KEC-316 • 411 4003316	修正 AMENDMENT KEC-318 • 411 4003318	掛號 REGISTERED KEC-321 • 411 4003321	私人密件 PRIVATE & CONFIDENTIAL KEC-322 • 411 4003322	急件 URGENT KEC-326 • 411 4003326	正本 ORIGINAL KEC-328 • 411 4003328
副本 COPY KEC-329 • 411 4003329	樣本 SAMPLE KEC-330 • 411 4003330	已檢查 CHECKED KEC-332 • 411 4003332	傳真 FAXED KEC-334 • 411 4003334	草稿 DRAFT KEC-336 • 411 4003336	完成 COMPLETED KEC-337 • 411 4003337	密件 CONFIDENTIAL KEC-347 • 411 4003347	證明副本 CERTIFIED TRUE COPY KEC-363 • 411 4003363

訂造原子印

Xstamper QuiX
Shachihata

- 防水油墨
- 可加墨
- 15種呎吋/5種顏色供選擇
- 可蓋印5,000至6,000次不用加墨
- 無論是面孔、簽名或公司Logo，清晰度極高
- 如設計稿完成後取消訂單，將會收取印章之30%作為稿件設計費用



*需另行購買補充墨水

10ml 防水專用補充墨水
(只適於本產品)

QPTLR-10

- 黑色 ■ 068 8008015
- 藍色 ■ 068 8008025
- 紅色 ■ 068 8008075
- 綠色 ■ 068 8008045
- 紫色 ■ 068 8008065

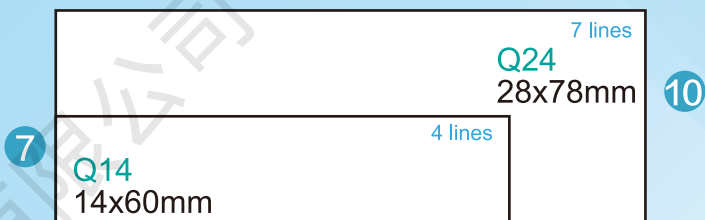
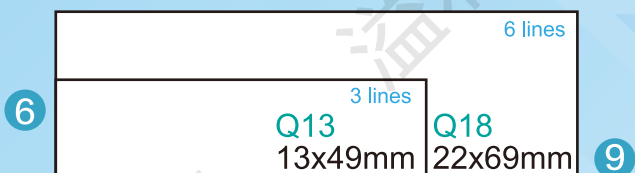
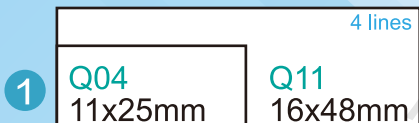
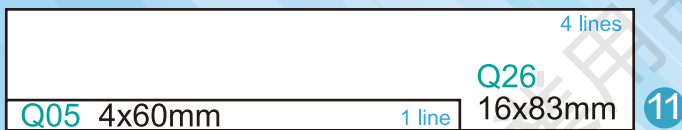
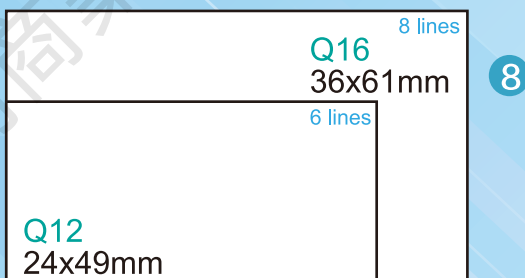
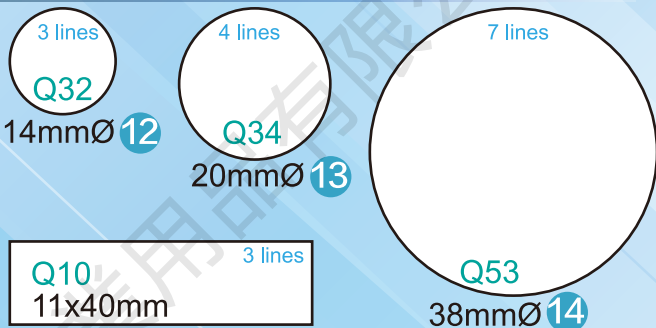

8 Q16

Ryan Lee

3 Q10



13 Q34

For and on behalf of
Lat Lei Stationery Limited
溢利商業用品有限公司

Authorized Signature(s)

5 Q12

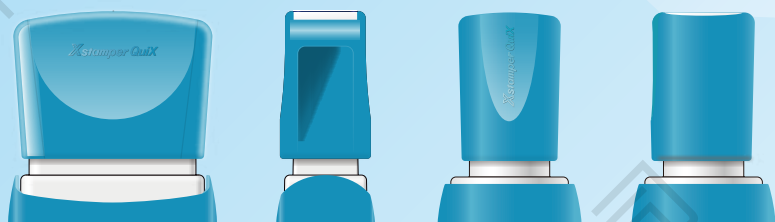

型號	貨品編號	呎吋
1 Q04	061 4Q04	11 x 25mm
2 Q05	061 4Q05	4 x 60mm
3 Q10	061 4Q10	11 x 40mm
4 Q11	061 4Q11	16 x 48mm
5 Q12	061 4Q12	24 x 49mm
6 Q13	061 4Q13	13 x 49mm
7 Q14	061 4Q14	14 x 60mm
8 Q16	061 4Q16	36 x 61mm
9 Q18	061 4Q18	22 x 69mm
10 Q24	061 4Q24	28 x 78mm
11 Q26	061 4Q26	16 x 83mm
12 Q32	061 4Q32	14mmØ
13 Q34	061 4Q34	20mmØ
14 Q53	061 4Q53	38mmØ

光敏印系列

TL可補充墨原子印章

備有其他呎吋，歡迎查詢

15



For and on behalf of

Iat Lei Stationery Limited
溢利商業用品有限公司

Authorized Signature(s)



TL-3051
27 x 48mm

補充墨水
10ml



	Code	Ref	Size (mm)
1	411 40TL036	TL-036	Ø 32
2	411 4TL1535	TL-1535	12 X 32
3	411 4TL1851	TL-1851	15 X 48
4	411 4TL1965	TL-1965	15 X 62
5	411 4TL18102	TL-18102	15 X 99
6	411 4TL2561	TL-2561	22 X 58
7	411 4TL2576	TL-2576	22 X 73
8	411 4TL25102	TL-25102	22 X 99
9	411 4TL3051	TL-3051	27 X 48
10	411 4TL3061	TL-3061	27 X 58
11	411 4TL30102	TL-30102	27 X 99
12	411 4TL4251	TL-4251	39 X 48
13	411 4TL4280	TL-4280	39 X 77
14	411 4TL5555	TL-5555	52 X 52
15	411 4TL5585	TL-5585	52 X 82
16	411 4TL6181	TL-6181	58 X 78
17	411 4TL7297	TL-7297	72 X 97

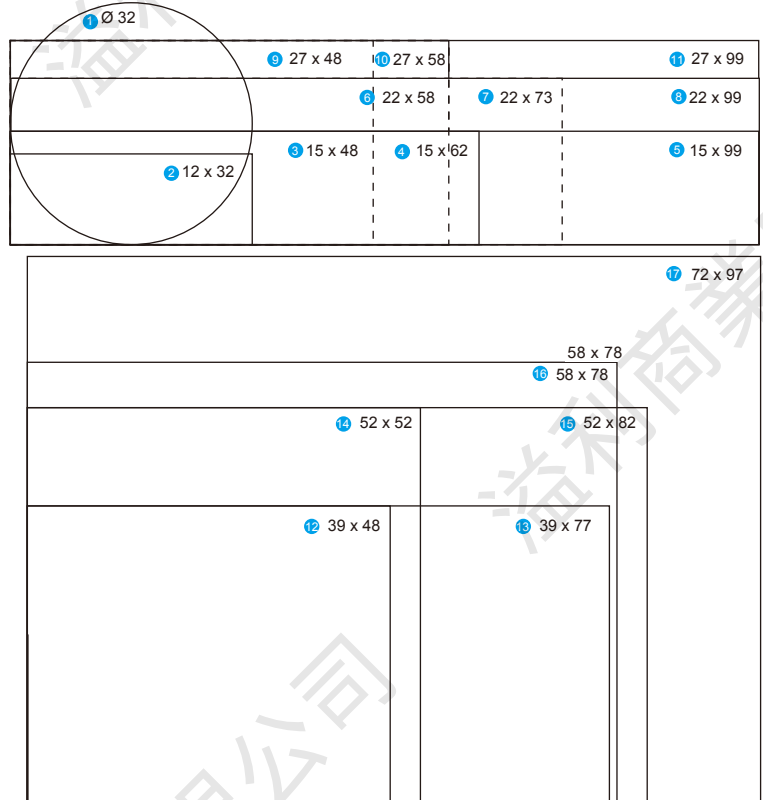

Desktop Products & Stamps

- If cancel order after artwork finish, we will charge stamp value 30% for design fee.
- Stamp artwork confirmation will be sent to client by email on next working day. (We do not accept any correction or cancel order after artwork confirmed.)
- Allow 7 - 10 days for delivery after artwork confirmed.
- 如設計稿件完成後消訂單，將會收取印章之30%作為設計費用
- 印章設計稿件將會一日後以電郵回覆作為最後確認。(在印章設計稿件確認後，我們不會接受任何修改或取消訂單)
- 確認後之印章設計稿件將會在7至10個工作天後送貨。

Hotline: 2871 9131

CS-945
6 x 42mm



CC可補充墨原子印章

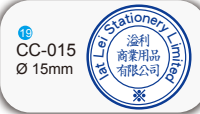
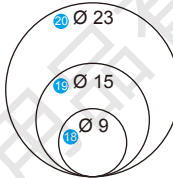

	Code	Ref	Size (mm)
18	411 40CC012	CC-012	Ø 9
19	411 40CC015	CC-015	Ø 15
20	411 40CC023	CC-023	Ø 23

CS 可補充墨原子印章



	Code	Ref	Size (mm)
21	411 40CS926	CS-926	6 X 23
22	411 40CS945	CS-945	6 X 42
23	411 40CS965	CS-965	6 X 62

RP 自動上墨印章/日期印章



3mm

4mm

日期位置會在印章的中央



RP-0030D
Ø 30mm

防滑設計 位置指示 透明框邊 鎖定更換墨墊 鎖定蓋印位置



Year Period
年期 12

日期印章 3mm

	Code	Ref	Size (mm)
24	411 4RP0030D	RP-0030D	Ø 30
25	411 4RP0040D	RP-0040D	Ø 40
26	411 4RP4242D	RP-4242D	42 X 42

日期印章 4mm

	Code	Ref	Size (mm)
27	411 4RP2441D	RP-2441D	24 X 41
28	411 4RP3050D	RP-3050D	29 X 49
29	411 4RP4060D	RP-4060D	38 X 58



	Code	Ref	Size (mm)
30	411 4RP0040	RP-0040	Ø 40
31	411 4RP2020	RP-2020	20 X 20
32	411 4RP2525	RP-2525	25 X 25
33	411 4RP3050	RP-3050	29 X 49
34	411 4RP1070	RP-1070	9 X 69
35	411 4RP2565	RP-2565	25 X 65
36	411 4RP3977	RP-3977	39 X 77
37	411 4RP4060	RP-4060	40 X 60

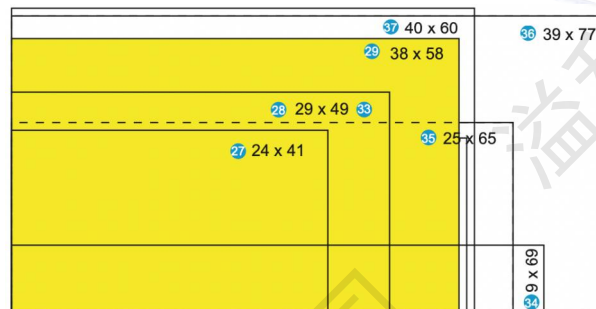
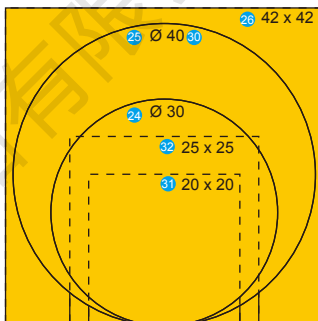

備有其他呎吋，歡迎查詢

膠壓印系列

applestamp 可補充墨原子印章

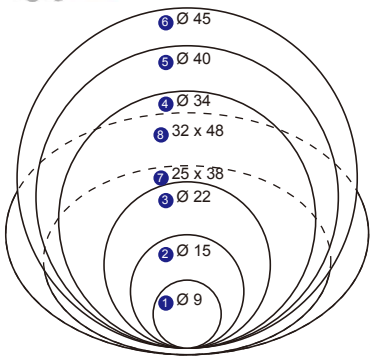

紫 紅 黑 綠 桃紅
5種顏色選擇，可訂造兩色

Code	Ref	Size (mm)
1 400 050PR10	PR10	Ø 9
2 400 050PR15	PR15	Ø 15
3 400 050PR22	PR22	Ø 22
4 400 050PR34	PR34	Ø 34
5 400 050PR40	PR40	Ø 40
6 400 050PR45	PR45	Ø 45
7 400 050POV1	POV1	25 X 38
8 400 050POV2	POV2	32 X 48



lat Lei Stationery Limited
溢利商業用品有限公司

1 P136
13 x 76.5mm



6 POV2
32 x 48mm

呎吋未能盡錄，最大可達 90X270mm

23 45 x 51	24 45 x 76.5	25 45 x 101	26 45 x 127
17 25.5 x 39	18 25.5 x 51	19 25.5 x 63.5	20 25.5 x 76.5
12 19 x 19	13 19 x 51	14 19 x 63.5	15 19 x 76.5
9 13 x 13	10 13 x 51	11 13 x 76.5	16 19 x 101
			21 25.5 x 101
			22 25.5 x 127

Code	Ref	Size (mm)
9 400 050P131	P131	13 X 13
10 400 050P133	P133	13 X 51
11 400 050P136	P136	13 X 76.5
12 400 050P191	P191	19 X 19
13 400 050P193	P193	19 X 51
14 400 050P195	P195	19 X 63.5
15 400 050P196	P196	19 X 76.5
16 400 050P198	P198	19 X 101
17 400 050P262	P262	25.5 X 39
18 400 050P263	P263	25.5 X 51
19 400 050P265	P265	25.5 X 63.5
20 400 050P266	P266	25.5 X 76.5
21 400 050P268	P268	25.5 X 101
22 400 050P269	P269	25.5 X 127
23 400 050P453	P453	45 X 51
24 400 050P456	P456	45 X 76.5
25 400 050P458	P458	45 X 101
26 400 050P459	P459	45 X 127



- If cancel order after artwork finish, we will charge stamp value 30% for design fee.
- Stamp artwork confirmation will be sent to client by email on next working day. (We do not accept any correction or cancel order after artwork confirmed.)
- Allow 7 - 10 days for delivery after artwork confirmed.
- 如設計稿件完成後消訂單，將會收取印章之30%作為設計費用
- 印章設計稿件將會一日後以電郵回覆作為最後確認。(在印章設計稿件確認後，我們不會接受任何修改或取消訂單)
- 確認後之印章設計稿件將會在7至10個工作天後送貨。

trodax 自動回墨印章

備有其他呎吋，歡迎查詢

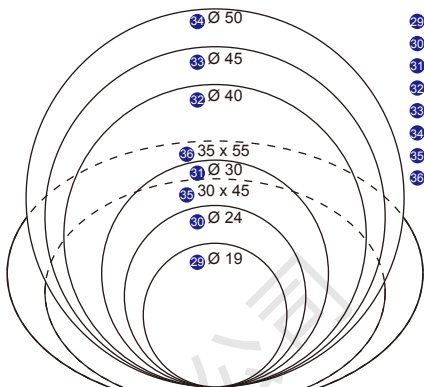

4種顏色選擇，如使用紫外光油墨需另行訂購

紫 紅 黑 綠 紫外光

訂做重型自動上墨印章



Code	Ref	Size (mm)
400 070TS23	TS23	28 X 49
400 070TS26	TS26	40 X 60
400 070TS28	TS28	46 X 68
400 070TS29	TS29	55 X 85

日期印章 墨墊顏色紫色(日期紅色)

Code	Ref	Size (mm)
400 070TD23	TD23	28 X 49
400 070TD26	TD26	40 X 60
400 070TD28	TD28	46 X 68
400 070TD29	TD29	55 X 85

Code	Ref	Size (mm)
27 400 070TR19	TR19	Ø 19
28 400 070TR24	TR24	Ø 24
29 400 070TR30	TR30	Ø 30
30 400 070TR40	TR40	Ø 40
31 400 070TR45	TR45	Ø 45
32 400 070TR50	TR50	Ø 50
33 400 070TOV4	TOV4	30 X 45
34 400 070TOV5	TOV5	35 X 55



35 40 x 40	36 40 x 60	37 38 x 75
38 30 x 30	39 30 x 50	40 30 x 69
41 20 x 20	42 18 x 47	43 22 x 58
44 12 x 12	45 14 x 38	46 15 x 75
		47 10 x 70
		48 25 x 82

Code	Ref	Size (mm)
400 070TQ12	TQ12	12 X 12
400 070TQ20	TQ20	20 X 20
400 070TQ30	TQ30	30 X 30
400 070TQ40	TQ40	40 X 40
400 070TL53	TL53	30 X 50
400 070TL55	TL55	40 X 60
400 070TL20	TL20	14 X 38
400 070TL30	TL30	18 X 47
400 070TL40	TL40	22 X 58
400 070TL50	TL50	30 X 69
400 070TL60	TL60	38 X 75
400 070TL15	TL15	10 X 70
400 070TL25	TL25	15 X 75
400 070TL35	TL35	25 X 82

自動回墨日期印章

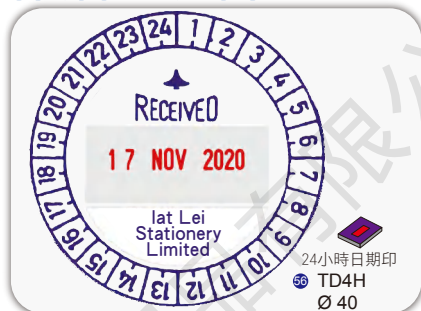

日期印章 墨墊顏色紫色(日期紅色)

Code	Ref	Size (mm)
400 070TD52	TD52	24 x 41
400 070TD53	TD53	30 x 50
400 070TD44	TD44	39 x 39
400 070TD55	TD55	40 x 60
400 070TD4H	TD4H	Ø 40
400 070TD30	TD30	Ø 30
400 070TD40	TD40	Ø 40
400 070TD50	TD50	Ø 50

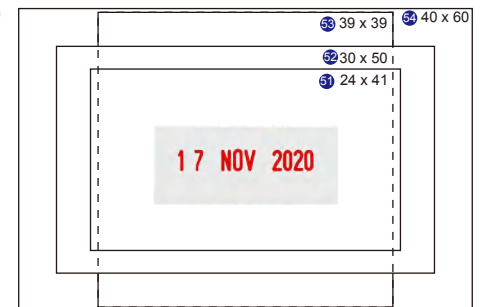

桌面用品與印章

Desktop Products & Stamps

15



全新A4/F4環保快勞 紙質材料獲得FSC森林認證

種類：硬皮快勞
物料：FSC紙板及金屬扣
面板：啞面
顏色：11種顏色（啞光彩色系）
包裝：PP袋獨立包裝

型號	規格		包裝
GX-EF993	F4	2吋	12個/箱
GX-EF994		3吋	
GX-EA995	A4	2吋	
GX-EA996		3吋	

面料採用時尚特種紙
令產品更為亮麗奪目



感受我們的

與眾不同

SMART GREEN



1500克特厚紙版

紙板平滑 手感舒適不刮手
FSC環保物料紙板
提升企业形象

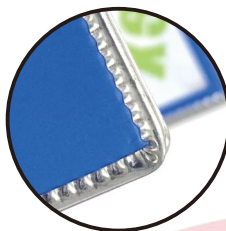

金屬波浪包邊設計

加強底部保護 不易破損更耐磨
貼心圓角設計 防止刮碰及損傷



高質量金屬鐵夾

堅固耐用 不易變形
滿載文件 得心應手



簡約背條標籤

脊背搭配貼心耐用指孔
完美延伸環保快勞概念